

Button operated, Spring return

Z03 0604 02

Type : 3/2 Spool Valve
 Manually operated
 Port Size : G 1/4
 Operating Pressure : 2-10 bar
 Operating Temperature : +5°C to +70°C
 Operating Force : 53 N

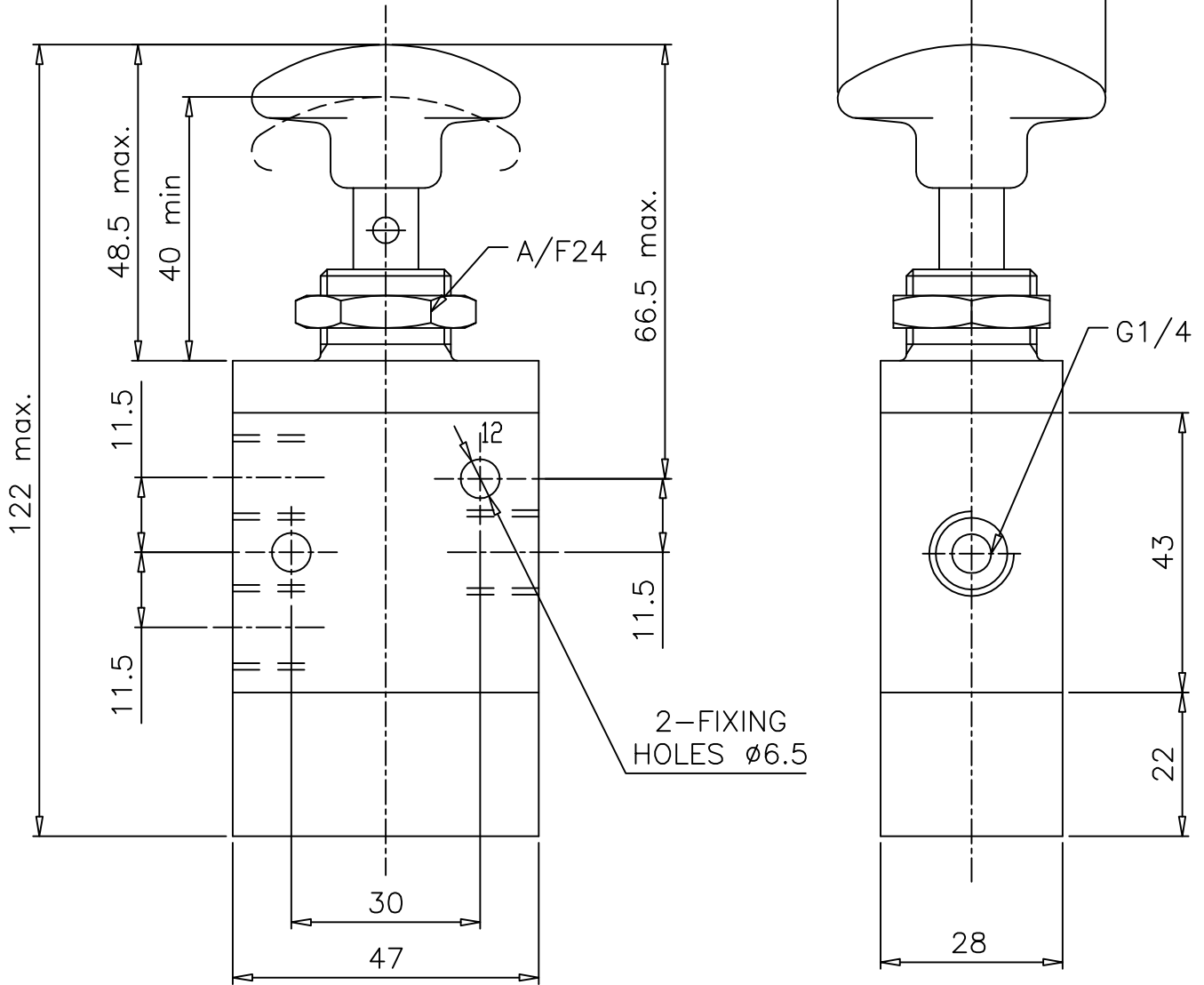
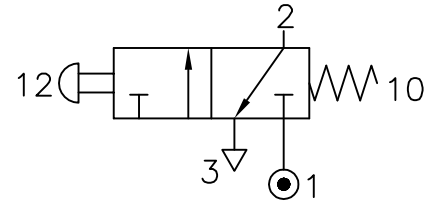

NOTE:-

- a) This valve is suitable for panel mounting and includes a nut and washer.
- b) Panel hole Ø 21mm.
- c) Panel thickness : 8mm (max.)

ALL DIMENSIONS ARE IN mm

DRAWN	SREENIVAS.M	16.04.2005
CHECKED		
APPROVED		