

# Lever Operated, Set - Reset

## ZNCN/1704/7

Type : 5/2  
 Port Size : G1/2  
 Operating Pressure : 2 - 10 bar  
 Operating Temperature : 0°C to +80°C

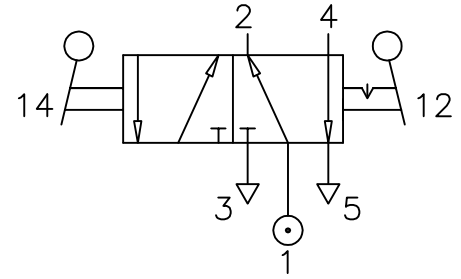

### MATERIAL OF CONSTRUCTION

Body : Aluminium  
 Seals : Nitrile

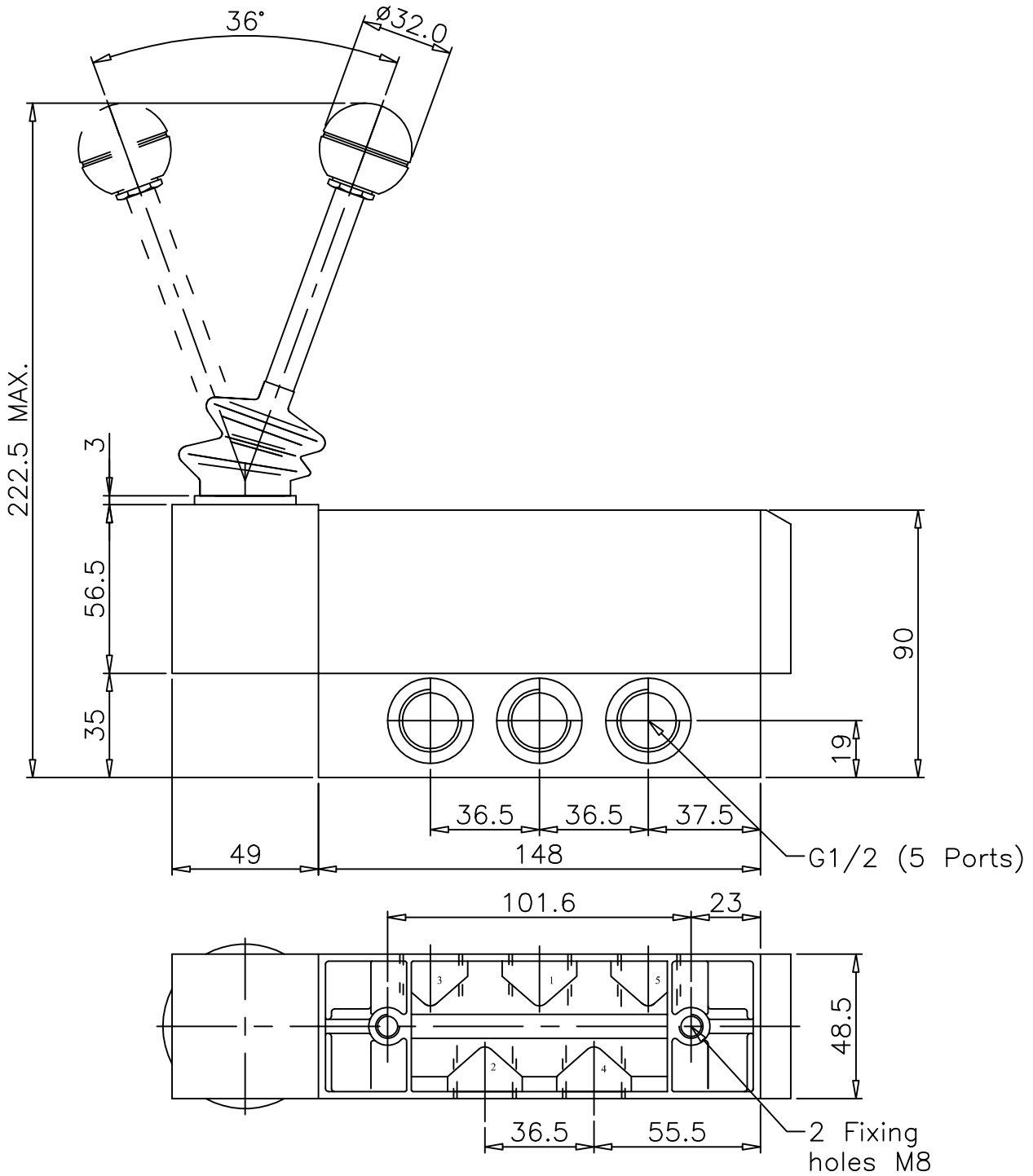

ALL DIMENSIONS ARE IN mm

NUCON INDUSTRIES PRIVATE LIMITED  
 88 , C.I.E , BALANAGAR ,  
 HYDERABAD - 500 037

DRAWN	T.Prabhakar	19.11.2007
CHECKED		
APPROVED		