

TECHNICAL SPECIFICATIONS

ZNCN/3060

- 1. TYPE : DOUBLE ACTING IMPACT CYLINDER
- 2. MEDIUM : COMPRESSED AIR, FILTERED & LUBRICATED
- 3. OPERATING PRESSURE : 4-10bar
- 4. RATED PRESSURE : 5.5bar
- 5. OPERATING TEMPERATURE : +80 °C

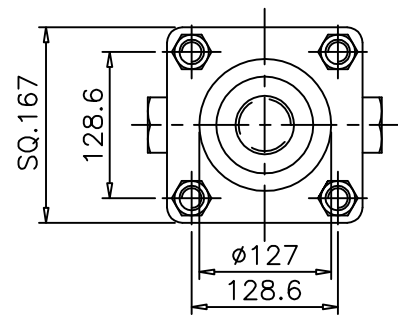
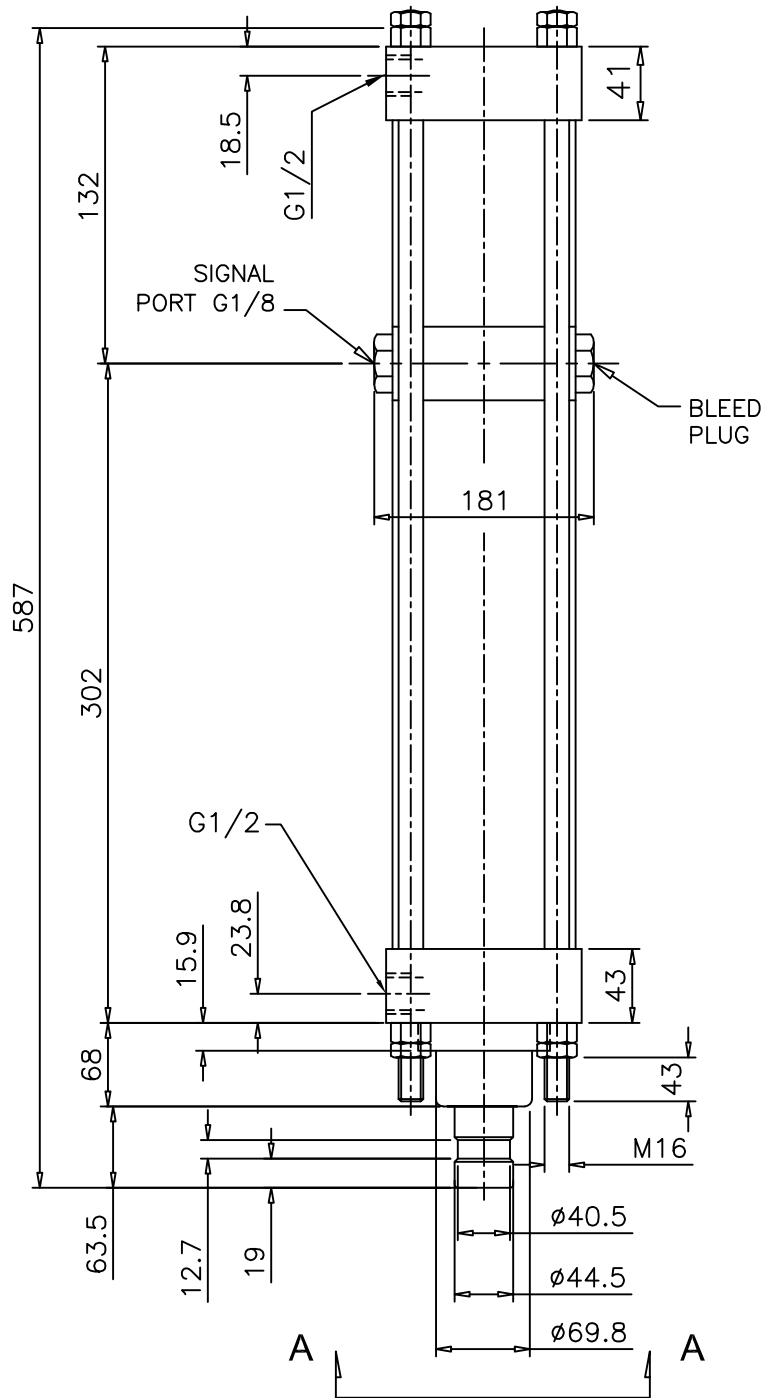
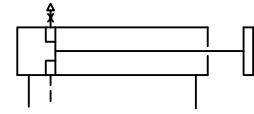

VIEW FROM ARROW A-A

NUCON ZANDER
 (A UNIT OF NUCON INDUSTRIES PVT. LTD.)
 88, CIE, BALANAGAR
 HYDERABAD -500 037. INDIA

DRAWN	T.Prabhakar	24.03.2007
CHECKED		
APPROVED		