

G1/4, 5/3 SOLENOID PILOT OPERATED FULLY SEALED, MID POSITION

ZNIV522X000

TECHNICAL SPECIFICATIONS

Medium : Compressed air
Operating pressure : 1.5 - 8 bar
Operating temperature : + 50°C
Flow Cv : 0.89

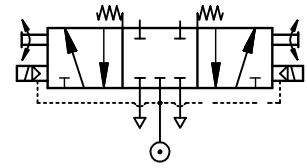

ELECTRICAL

Coil Voltage 000 : 220V AC ; 50-60Hz (Code : 137)
 : 110V AC ; 50-60Hz (Code : 131)
 : 24V DC (Code : 10)
Insulation : Class 'F'
Protection Class : IP 65
Terminal Box : 3 Pin plug to IP 65
Power consumption : AC 3.5VA
 : DC 2.5W

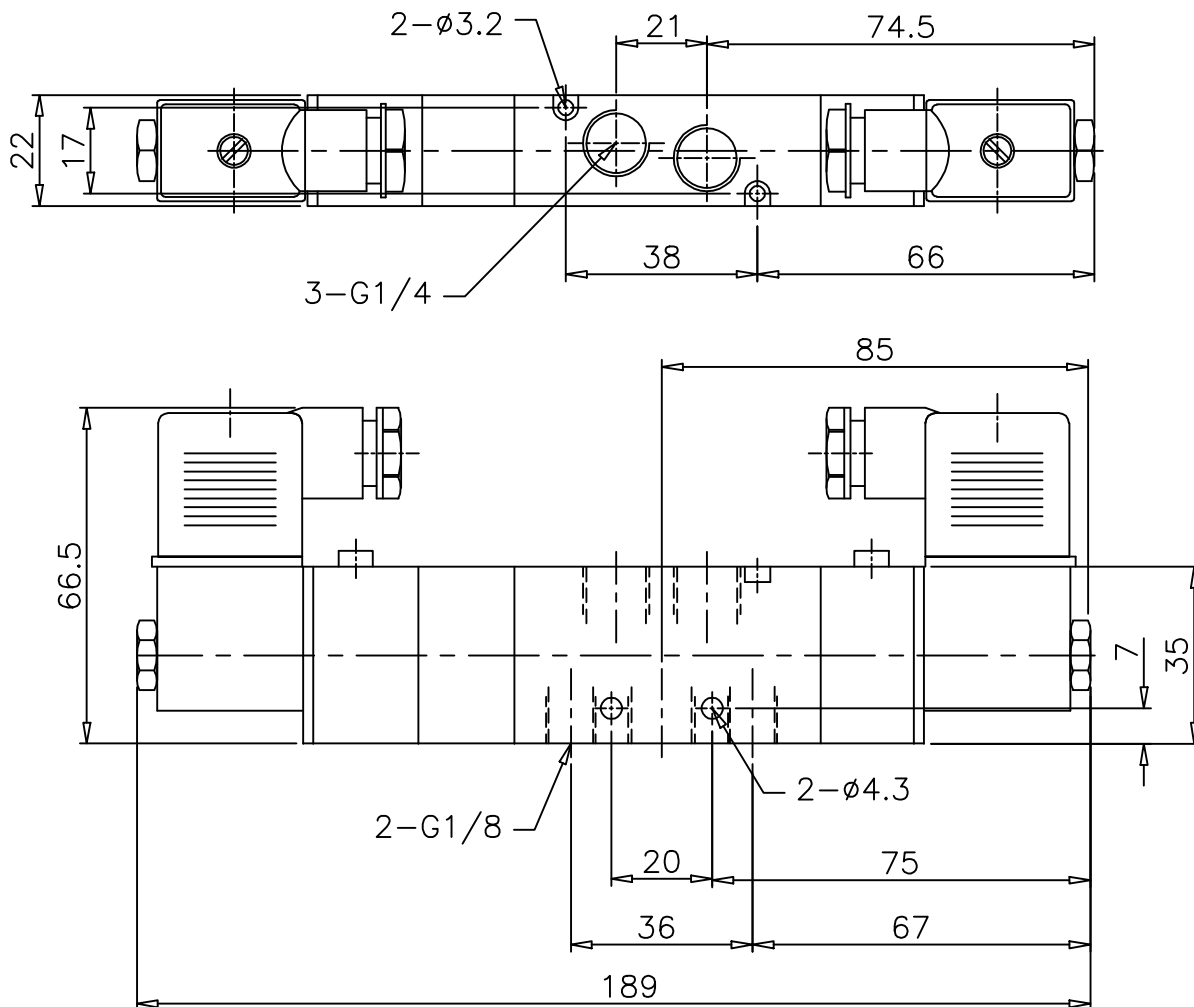

ALL DIMENSIONS ARE IN mm

NUCON INDUSTRIES PRIVATE LIMITED
 88, C.I.E , BALANAGAR ,
 HYDERABAD - 500 037

DRAWN	T.Prabhakar	07.05.2009
CHECKED		
APPROVED		